

DRAWER BASE CABINET (PA)

CODE	ITEM	QTY
A	Right Left Side Panel	2
C	Drawer Right Left Side Panel	6
D	Bottom Panel	1
E	Drawer Back Panel	3
F	Drawer Bottom Panel	3
H	Back Panel	1
J	Toe Kick Plate	1
K	Drawer Glide-Cabinet	6
L	Drawer Glide-Drawer	6
M	Front Face	1
N	Drawer Front Panel	3
T	Rear Slide Bracket	6

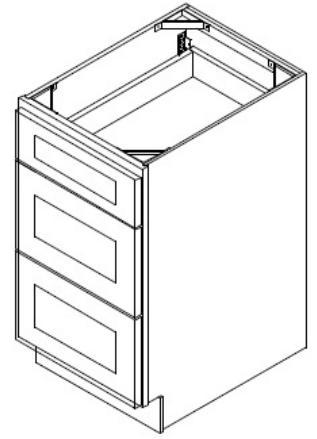

EASY ASSEMBLY METAL CLIP SYSTEM



- Align Clips ① and ②
- Slide ① into ②
- Insert locking screw into clip pair
- Tighten all screws

STEP 1

- Lay H flat; grooves facing upward
- Insert A into metal clips of H (refer to Metal Clip System)

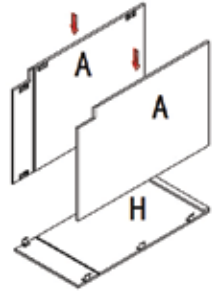

STEP 2

- Slide D into grooves of A and H

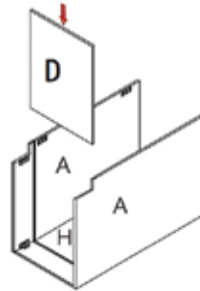

STEP 3

- Attach M onto D and A (refer to Metal Clip System)
- Attach J onto bottom front of A using the Metal Clip System

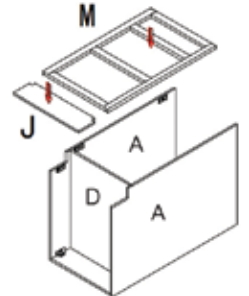

STEP 4

- Align C Right | Left with E so that the grooves line up and screw together
- Slide F into grooves of C and E
- Align N into C and F and tighten with screw

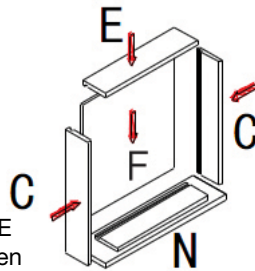

STEP 5

- Separate K and L of the drawer slide by extending slide and push down on black pin
- Attach drawer slide L to the pre-drilled holes on the two sides of C

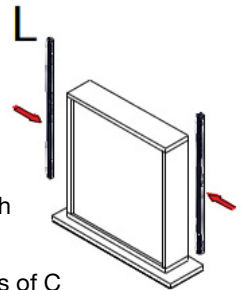

STEP 6

- Screw both rear brackets T into the pre-drilled holes in H
- Install K by sliding into T and screwing into side of M

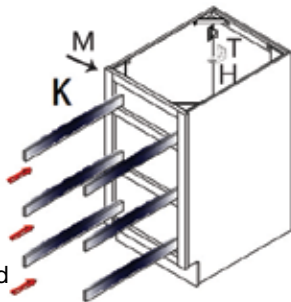

STEP 7

- Slide drawer box into cabinet so that L slides into K

